

USER MANUAL

HYT-5.0HV-EUG1
HYT-6.0HV-EUG1
HYT-8.0HV-EUG1
HYT-10.0HV-EUG1
HYT-12.0HV-EUG1











CONTENTS





1. Safety Introduction	02
1.1 Explanation of Symbols	02
1.2 Safety Information	03
2. Introduction	05
2.1 Product Overview	05
2.2 Operating Modes	07
2.3 System Diagram	09
2.3.1 Basic Diagram	10
2.3.2 Retrofit System	12
3. Installation Instruction	13
3.1 Packing List	13
3.2 Mounting	14
3.2.1 Selecting the Mounting Location	14
3.2.2 Mounting Inverter	15
3.3 Electrical Wiring Connection	15
3.3.1 Grounding Connection	15
3.3.2 PV Wiring Connection	16
3.3.3 Battery Wiring Connection	17
3.3.4 AC Wiring Connection	18
3.3.4.1 Grid Connection	18
3.3.4.2 EPS Connection	19
3.3.5 Communication Wiring Connection	20
3.3.5.1 BMS Connection	21
3.3.5.2 Smart Meter and CT Connection	22
3.3.5.3 DRM Connection	23
3.3.5.4 DI Connection	24
3.3.5.5 DO Connection	24
3.3.5.6 Parallel Connection	25
3.3.6 DTS Connection	25
3.4 Operation	26
3.4.1 S-Miles Cloud APP	26
3.4.2 Commissioning	27
3.4.3 Decommissioning	27
4. Troubleshooting	28
5. Technical Datasheet	31
6. Contact Information	33

1. Safety Introduction

1.1 Explanation of Symbols

The following types of safety precautions and general information symbols used in this manual must be followed during the installation, operation, and maintenance of the inverter.

Symbol	Usage
	Indicates a hazard with a high level of risk that, if not avoided, will result in death or serious injury.
	Indicates a hazard with a medium level of risk that, if not avoided, can result in death or serious injury.
	Indicates a hazard with a low level of risk that, if not avoided, can result in minor or moderate injury.
	Indicates a situation that, if not avoided, can result in property damage. NOTICE is used to address practices not related to personal injury.
	Caution! Failure to observe any warnings contained in this manual may result in injury.
	Danger to life due to high voltages! Only qualified personnel can open and maintain the inverter.
	Burn danger due to hot surface that may exceed 60°C.
	Refer to the operating instructions.
	Wait for at least 10 minutes before opening the inverter or touching live parts.
	Products shall not be disposed as household waste.
	CE mark.



	<p>This side up! This package must always be transported, handled and stored in such a way that the arrows always point upwards.</p>
	<p>Fragile - The package/product should be handled carefully and should never be tipped over or slung.</p>
	<p>Keep dry! The package/product must be protected from excessive humidity and must be stored under cover.</p>
	<p>No more than six (6) identical packages are to be stacked on each other.</p>



1.2 Safety Information

This chapter contains important safety and operating instructions. For future reference, please read and keep this manual.

For the purpose of preventing personal injury and property damage, as well as ensuring the long-term operation of the product, please read and follow all the instructions and cautions on the inverter and this user manual during installation, operation, and maintenance.

Safety instructions in this manual cannot cover all precautions that should be taken. Please consider the actual conditions on site when performing operations. Any damage caused by a violation of the safety instructions in this manual shall not be the responsibility of Hoymiles.

Symbol	Usage
	<p>Danger to life from electric shock</p> <ul style="list-style-type: none"> • Before performing any work on the inverter, disconnect all DC and AC power from inverter and wait for at least 10 minutes. Hazardous voltage will present for up to 10 minutes after disconnection from power supply. • Never insert or remove the AC or DC connections when the inverter is running. • Any live parts connected to battery port cannot be touched before removing all the power from inverter for 10 minutes because there is still danger to life even battery voltage is lower than 60V. • Do not touch DC conductors or any non-isolated cable ends. • The mounting location must be inaccessible to children. • Never touch either the positive or negative pole of PV connecting device. Strictly prohibit touching both at the same time.
	<p>Risk of burns from hot surfaces</p> <ul style="list-style-type: none"> • The surface of the inverter might exceed 60°C , touching the surface may result in burns. • Do not touch hot surfaces before the inverter cools down.

 <p>WARNING</p>	<ul style="list-style-type: none"> • Only authorized service personnel are allowed to install the inverter or perform servicing and maintenance. • All powers, both AC and DC, should be disconnected from inverter before attempting any maintenance, cleaning or working on any circuits connected to inverter. • Attempting to service the inverter yourself may result in a risk of electric shock or fire and will void your warranty. • Keep away from flammable, explosive materials to avoid fire disaster. • The installation place should be away from humid or corrosive substances. • The unit contains capacitors that remain charged to a potentially lethal voltage after the mains, battery and PV supply has been disconnected. • When accessing the internal circuit of inverter, wait for at least 10 minutes.
 <p>CAUTION</p>	<ul style="list-style-type: none"> • The inverter has a transformer-less design on PV side. Neither positive nor negative terminals of PV panels should be grounded. • The frames of PV panels should be grounded for safety reasons. • Ensure that existing wiring is in good condition and no wire is undersized. • Do not disassemble any parts of inverter which are not mentioned in installation. • Authorized service personnel must use insulated tools when installing or working with this equipment. • PV modules shall have an IEC 61730 class A rating.
 <p>NOTICE</p>	<ul style="list-style-type: none"> • All electrical connections must be in accordance with local and national standards. • Only with permission of the local utility grid company, the inverter can be connected to the utility grid. • Do not open the inverter cover or change any components without authorization, otherwise the warranty commitment for the inverter will be invalid. • Appropriate methods must be adopted to protect inverter from electrostatic discharge; any damage caused by ESD is not warranted by the manufacturer. • Prior to the application, please read this section carefully to ensure the correct and safe application. Please keep the user manual properly. • The manual contains no user-serviceable parts. See Warranty for instructions on obtaining service. • If an error occurs, refer to troubleshooting or contact your local distributor or qualified electricians.

2. Introduction

2.1 Product Overview

The HYT-HV Series is a high-performance three-phase hybrid inverter with excellent reliability. The intelligent EMS function supports self-consumption, economic, and backup modes for multi-scenario applications. Monitoring management through S-Miles Cloud allows users to remotely diagnose and track system’s performance over time, offering superior energy production.

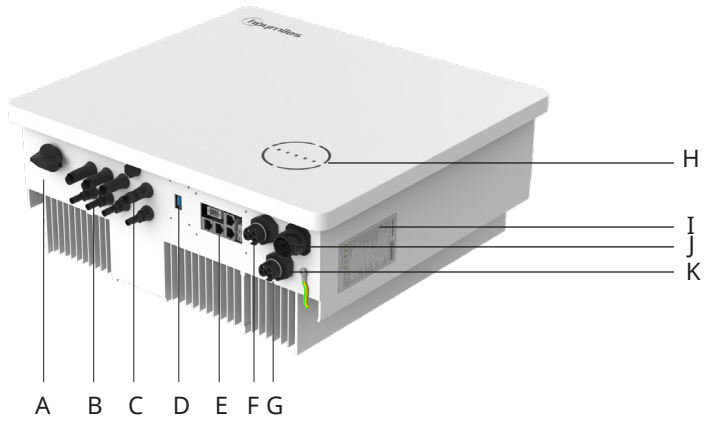

* The image shown here is for reference only. The actual product received may differ.

Object	Description
A	DC Switch
B	PV Terminals
C	Battery Terminals
D	Data Transfer Stick (DTS) Area
E	Communication Area
F	GRID Connector
G	Generator (GEN) Connector
H	LED Indicators
I	Label
J	Emergency Power Supply (EPS) Connector
K	PE Terminal
 WARNING	<ul style="list-style-type: none"> Prior to any electrical connections, keep in mind that the inverter has dual power supplies. It is mandatory for the qualified personnel to wear personal protective equipment (PPE) during the electrical work.

LED Indicators

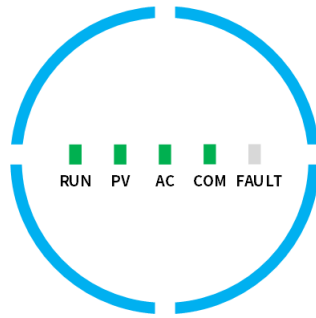

Indicator	Status	Explanation
SOC		Full circle LEDs on – SOC is 75-100% 3/4 circle LEDs on – SOC is 50-75% 2/4 circle LEDs on – SOC is 25-50% 1/4 circle LED on – SOC is 10-25% 1/4 circle LED blink – SOC is below 10% All circle LEDs off – No BMS communication
RUN		Off – Inverter is not operating Blink 1 – Inverter is booting Blink 2 – Inverter is in bypass mode On – Inverter is operating
PV		Off – PV voltage is low Blink 1 – PV power is low On – PV is generating power
AC		Off – Grid is disconnected and EPS is off Blink 1 – Grid is disconnected but EPS is on On – Grid is connected
COM		Off – Communication error of both meter and BMS Blink 1 – Communication failed to meter Blink 2 – Communication failed to BMS On – BMS and meter communications are OK
FAULT		Off – No fault On - A fault happens Blink 1 – EPS port overload Blink 2 – ISO/RCD fault Blink 3 – Arc fault

2.2 Operating Modes

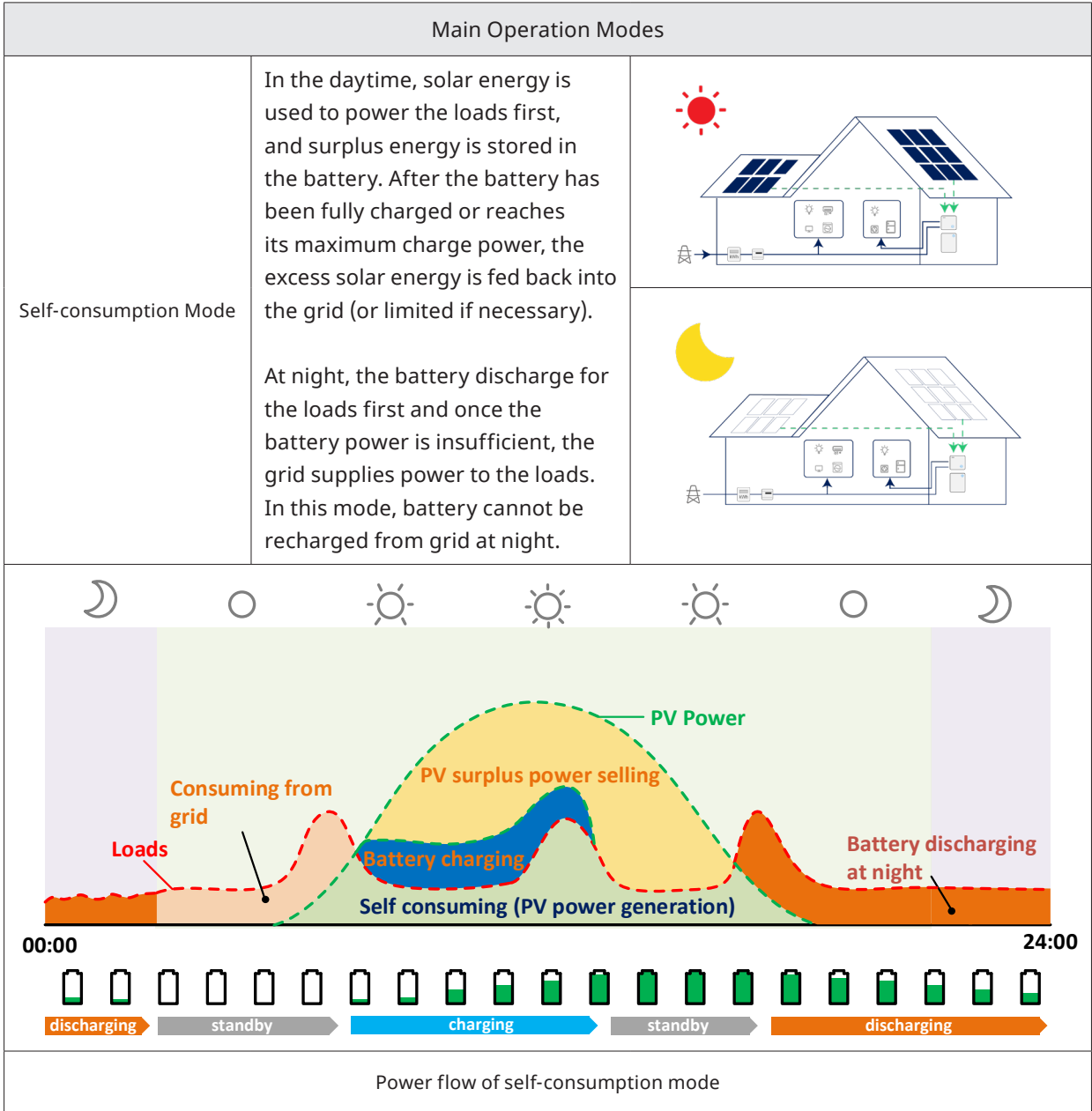

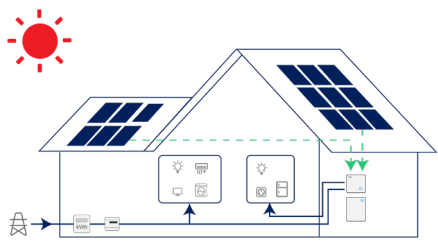
<p>Economic Mode</p>	<p>In this mode, the time of battery charge and discharge needs to be set. Meanwhile, the battery can be forced to charge from the grid during the preset charge time. For instance, the battery could be charged or discharged according to valley or peak electricity price.</p>	
----------------------	--	--

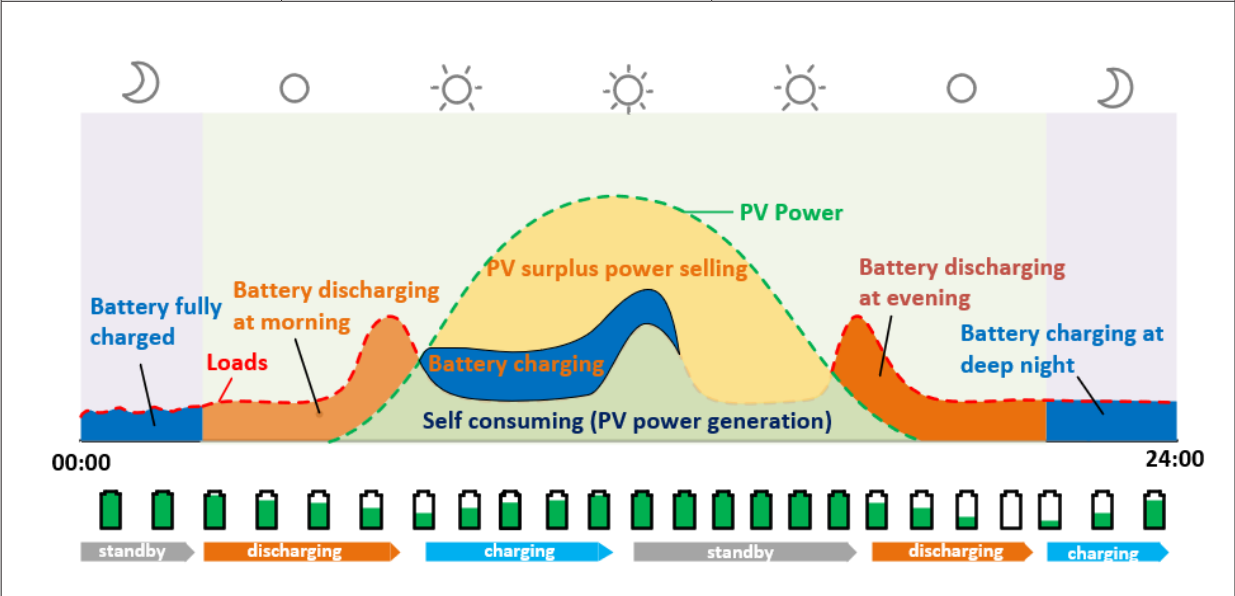

Power flow of back-up mode

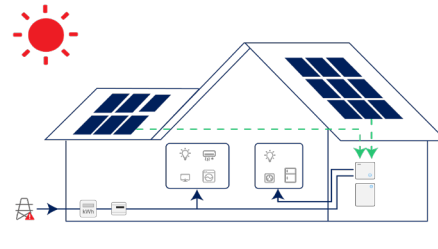
<p>Back-up Mode</p>	<p>In case of frequent power outages, a backup power SOC can be configured, which ensures that the battery always has enough energy to handle critical loads.</p>	
---------------------	---	--

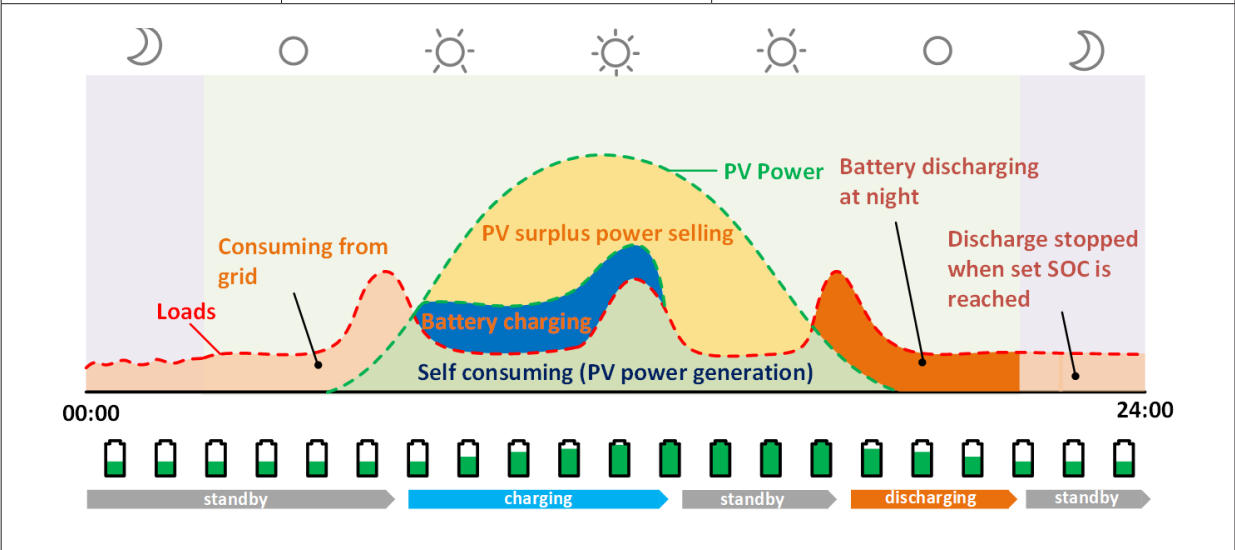

Power flow of back-up mode

2.3 System Diagram

The HYT-HV Series hybrid inverter can be connected to a battery and PV panels to form a PV Energy Storage System (ESS). In the event of a grid outage, it can be used as an emergency power supply (EPS) as well as for self-consumption of solar energy. It can either form a DC coupled system for a new installation or an AC coupled system to retrofit existing installations.

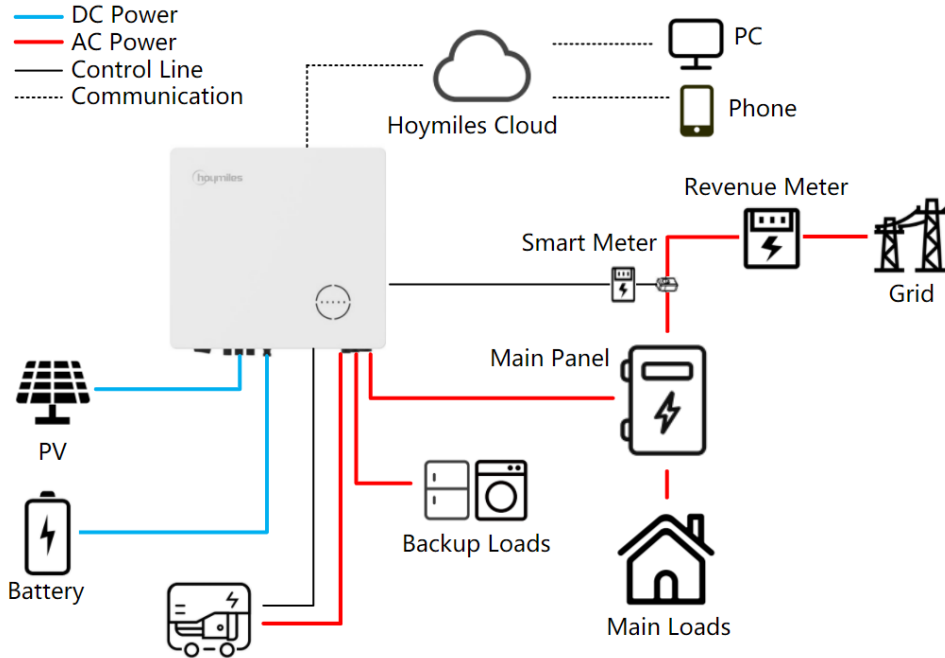

NOTICE

- This diagram is a simplified system sketch that is only intended to explain system architecture.
- Please refer to <https://www.hoymiles.com> for compatible battery list, user should first contact Hoymiles for technical consultation and obtain official confirmation prior to installing any battery not included in the official published list.

2.3.1 Basic Diagram

A. Diagram for Australia and New Zealand

 <p>NOTICE</p>	<ul style="list-style-type: none"> This diagram is an example of application that Neutral connects with PE in distribution box. For countries such as Australia, New Zealand, South Africa, etc., please follow local wiring regulations!
--	---

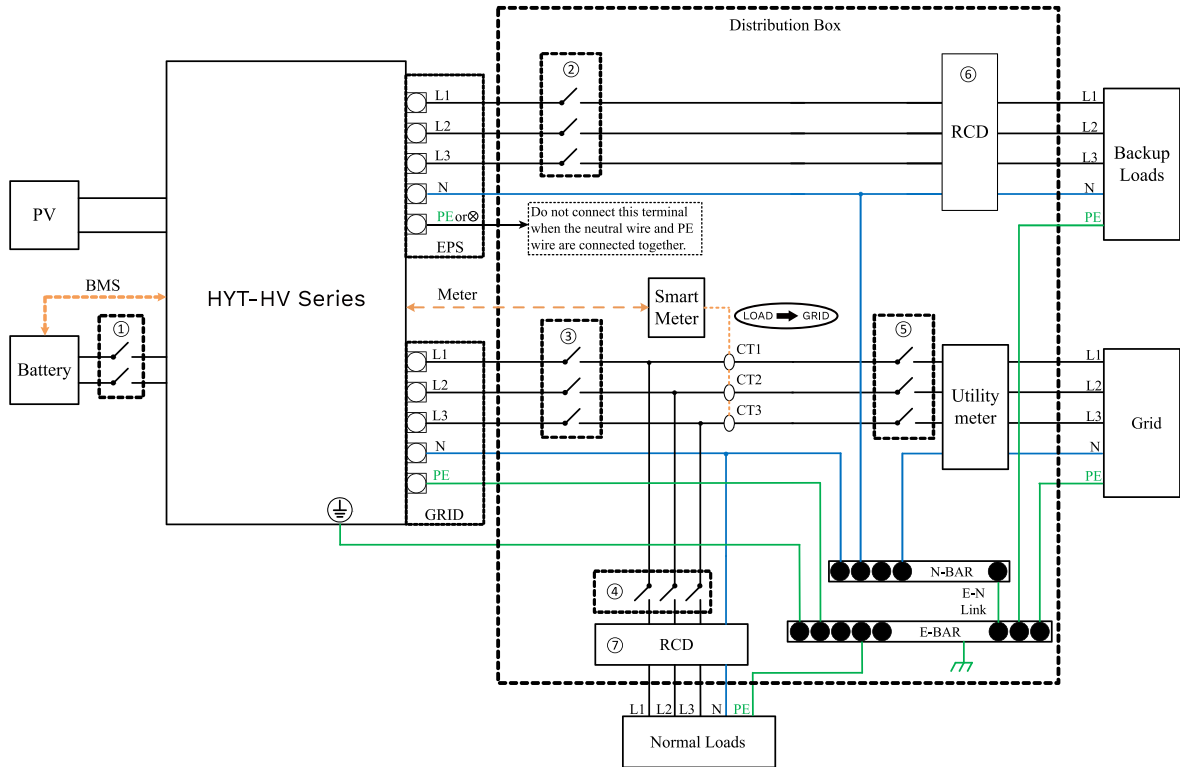

Model	①	②	③	④	⑤	⑥⑦
HYT-5.0HV-EUG1	25A/600V DC Breaker	16A/230V AC Breaker	20A/230V AC Breaker	Depends on Loads	Main Breaker	30 mA RCD
HYT-6.0HV-EUG1	25A/600V DC Breaker	16A/230V AC Breaker	25A/230V AC Breaker			
HYT-8.0HV-EUG1	40A/600V DC Breaker	20A/230V AC Breaker	32A/230V AC Breaker			
HYT-10.0HV-EUG1	40A/600V DC Breaker	25A/230V AC Breaker	32A/230V AC Breaker			
HYT-12.0HV-EUG1	40A/600V DC Breaker	25A/230V AC Breaker	32A/230V AC Breaker			

Note:

- If battery integrates a readily accessible internal DC breaker, no additional ① DC breaker is required.
- ⑥⑦ 30mA RCD is recommended not mandatory, please comply with local regulation, please comply with local regulation.

B. Diagram for Other Countries



NOTICE

- This diagram is an example for an application in which neutral is separated from the PE in the distribution box.
- For countries such as China, Germany, Italy, etc., please follow local wiring regulations!
- The back-up PE line and earthing bar must be grounded properly and effectively. Otherwise, the back-up function may be abnormal when the grid fails.

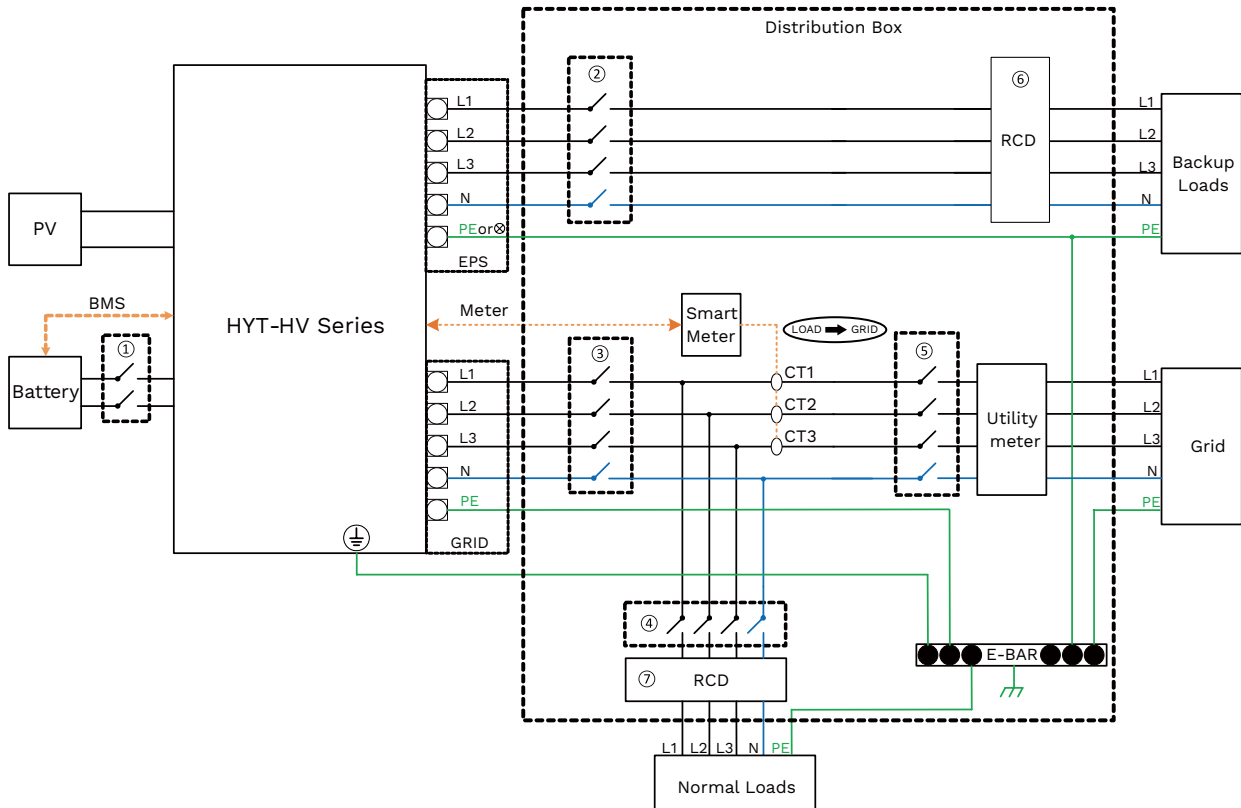

Model	①	②	③	④	⑤	⑥⑦
HYT-5.0HV-EUG1	25A/600V DC Breaker	16A/230V AC Breaker	20A/230V AC Breaker			
HYT-6.0HV-EUG1	25A/600V DC Breaker	16A/230V AC Breaker	25A/230V AC Breaker			
HYT-8.0HV-EUG1	25A/600V DC Breaker	20A/230V AC Breaker	32A/230V AC Breaker	Depends on Loads	Main Breaker	30mA RCD
HYT-10.0HV-EUG1	40A/600V DC Breaker	25A/230V AC Breaker	32A/230V AC Breaker			
HYT-12.0HV-EUG1	40A/600V DC Breaker	25A/230V AC Breaker	32A/230V AC Breaker			

Note:

- If battery integrates a readily accessible internal DC breaker, no additional ① DC breaker is required.
- ⑥⑦ 30mA RCD is recommended not mandatory, please comply with local regulation, please comply with local regulation.

2.3.2 Retrofit System

The HYT-HV series inverter is compatible with any three-phase PV grid-connected inverters. With the addition of the hybrid inverter, existing PV system can be retrofitted to be a PV ESS allowing more self-consumption energy and more backup energy.

The detailed wiring of your system depends on the requirements you have. Please consult your system integrator for more information.

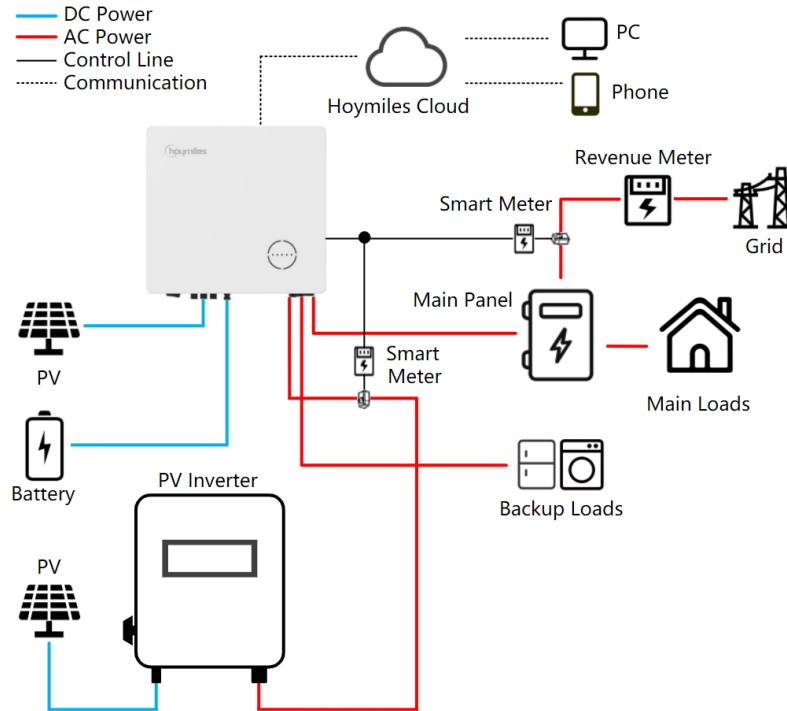

2.3.3 Unacceptable Diagram

Avoid the following installation types to prevent damage to the system or the inverter.

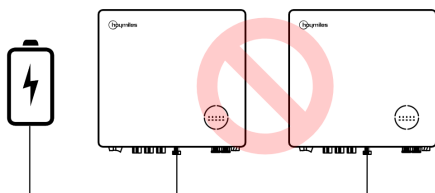

One battery cannot be connected to multiple inverters.

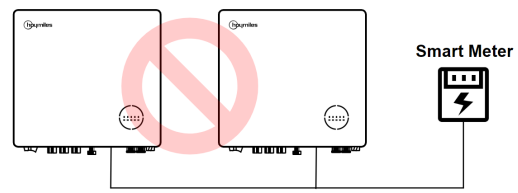

One meter cannot be connected to multiple inverters and different CTs cannot be connected to the same line cable.

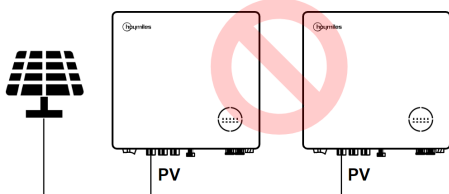

Single PV cannot be connected to multiple inverters.

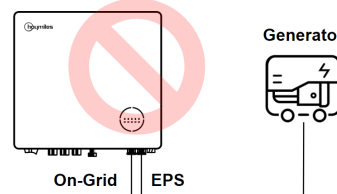

Neither EPS or on-grid port can be connected to generator directly.

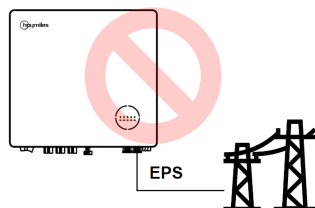

EPS port cannot be connected to grid directly.

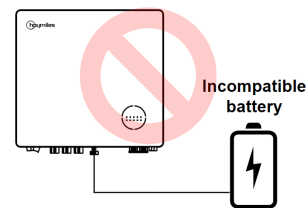

Incompatible battery cannot be connected to battery port.

3. Installation Instruction

3.1 Packing List

Please ensure that none of the components listed below are missing or damaged upon receipt of the hybrid inverter.

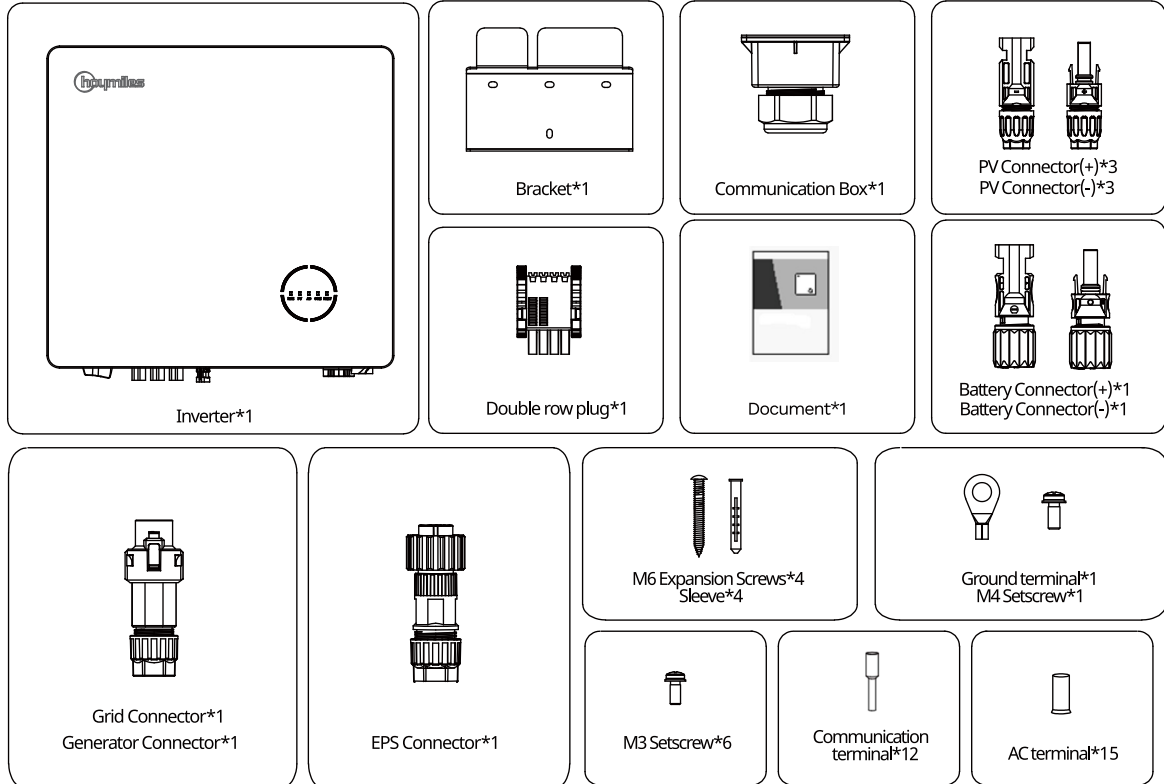

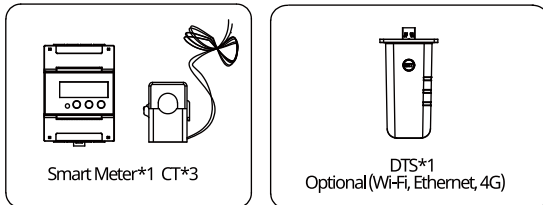

Accessories packing list



3.2 Mounting

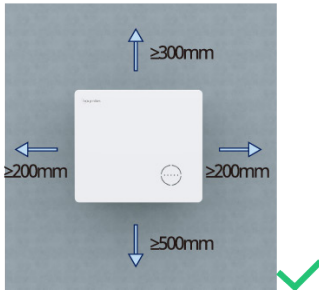
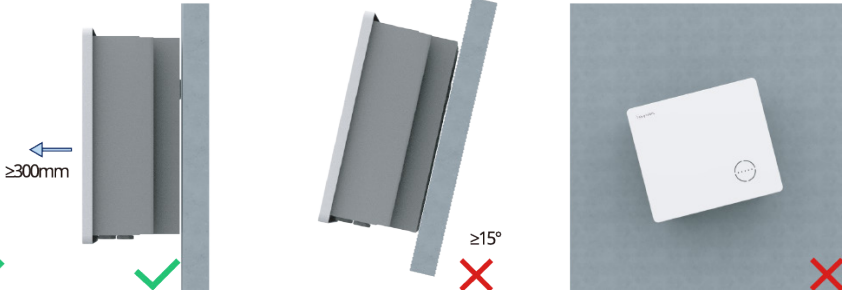

3.2.1 Selecting the Mounting Location

 <p>WARNING</p>	<ul style="list-style-type: none"> • Make sure there is no electrical connection before installation. • In order to avoid electric shock or other injuries, make sure that holes are not be drilled over any electrical parts or plumbing installations.
 <p>NOTICE</p>	<ul style="list-style-type: none"> • Make sure the inverter is correctly installed according to the following list. Any incorrect installation would require a risk assessment.

Check List	
<p>1. The inverter installation should be protected by shelter from direct sunlight or bad weather such as snow, rain or lightning.</p> <p>2. The inverter should be installed on a solid surface which is suitable for the inverter’s dimensions and weight.</p> <p>3. The inverter should be installed vertically or be on a slope with a maximum value of 15°. Leave enough space around the inverter according to the figure below.</p>	
	
<p>4. The ambient temperature should be between -25°C and 45°C. High ambient temperatures will cause power derating of the inverter.</p> <p>5. The relative humidity should be less than 95%, without condensing.</p> <p>6. The inverter should be installed at eye level for convenient maintenance.</p> <p>7. The product label on the inverter should be clearly visible after installation.</p> <p>8. The inverter should be installed far from flammable materials.</p>	

3.2.2 Mounting Inverter

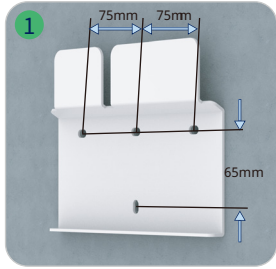
Install the inverter on the wall using the provided wall-mounting bracket and expansion plug sets.

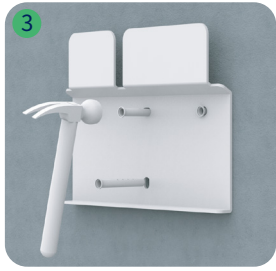
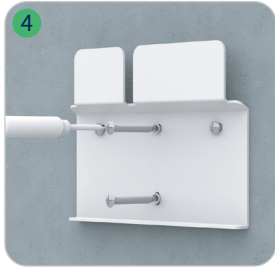
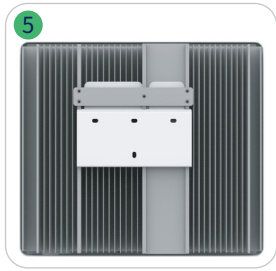
Procedure			
Step 1	Position the bracket against the wall and mark the 4 drilling hole locations.		
Step 2	Drill holes with a driller, make sure the holes are deep enough (at least 60 mm).		
Step 3	Place the expansion tubes in the holes, and tighten them.		
Step 4	Then install the wall bracket with the expansion screws. Please confirm that the bracket is firmly attached to the mounting surface.		
Step 5	Mount the inverter on the bracket.		

3.3 Electrical Wiring Connection

3.3.1 Grounding Connection

All non-current carrying metal parts and device enclosures in the PV power system should be grounded. There is an additional grounding terminal located at bottom right of the inverter, connect to a nearby grounding point.

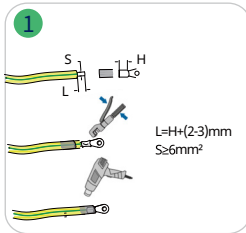
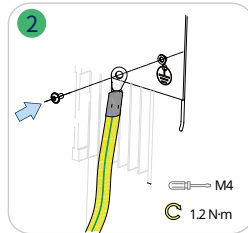
Procedure			
Step 1	Prepare the cable and OT/DT terminal.		
Step 2	Use the screw from the accessory box. Then fasten the cable with a screwdriver.		

3.3.2 PV Wiring Connection

 WARNING	<p>Before connecting, please make sure all requirements listed below are followed.</p> <ul style="list-style-type: none"> The voltage, current, and power ratings of the panels to be connected are within the allowable range of the inverter, ensure the polarity is correct, and please refer to the Technical Data in Chapter 5 for voltage and current limits. Since the inverter is a transformer-less structure, please do not ground either output of the PV panels. If the inverter is integrated with a PV switch, please make sure it is in the "off" position. Otherwise please use an external PV switch to cut off the PV connection during wiring and when necessary.
---	---

 NOTICE	<ul style="list-style-type: none"> Use the PV connectors in the accessory box for PV connections. Damage to the device due to the use of an incompatible terminal shall not be covered by the warranty. Please make sure the connectors are correct, not the battery connectors, as they look similar.
--	--

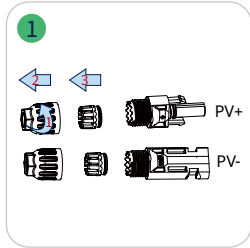
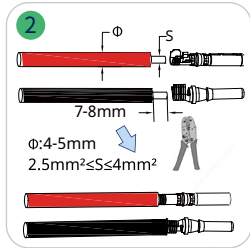
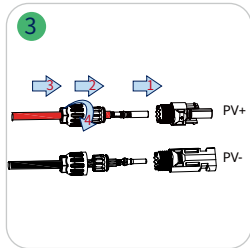
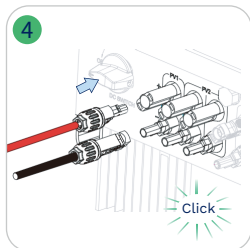

Procedure		
<p>Step 1</p> <ul style="list-style-type: none"> Unscrew the PV connector counterclockwise. Remove the insulator. Remove the inner cable gland. 		
<p>Step 2</p> <ul style="list-style-type: none"> Strip the insulation from each DC cable by 7-8 mm. The conduct core-section: 2.5-4 mm². Assemble cable ends with crimp contacts by crimping pliers. 		
<p>Step 3</p> <ul style="list-style-type: none"> Lead the cable through the cable gland. Insert the crimp contact into the insulator until it snaps into place. Gently pull the cable backward to ensure a firm connection. Tighten the cable gland and the insulator. 		
<p>Step 4</p> <ul style="list-style-type: none"> Check the cable connection of the PV string for polarity correctness and ensure that the open-circuit voltage in any case does not exceed the inverter input limit of 1,000V Connect the PV connectors to the inverter. There should be a "click" if it is plugged in correctly. 		

3.3.3 Battery Wiring Connection

This section mainly describes the cable connections on the inverter side. Refer to the instructions supplied by the battery manufacturer for the connections on the battery side.

For batteries without a built-in DC breaker, make sure that an external DC breaker is connected.

If you need to use this hybrid inverter as a grid-tied inverter, please contact Hoymiles for help.

 WARNING	<ul style="list-style-type: none"> • A two-pole DC breaker with OCP function is compulsory to be installed between the inverter and battery. The battery may have this switch integrated. If not, an external DC switch of proper ratings should be used. • Make sure the breaker mentioned above is in the "off" position.
 NOTICE	<ul style="list-style-type: none"> • Use the battery connectors in the accessory box for battery connections.

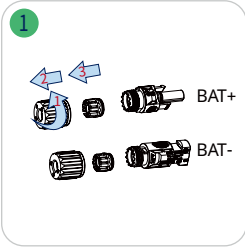
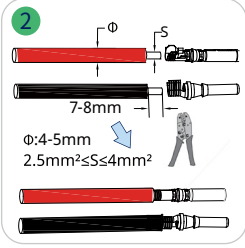
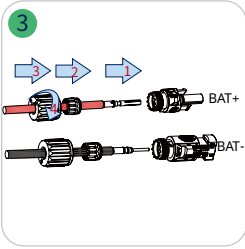
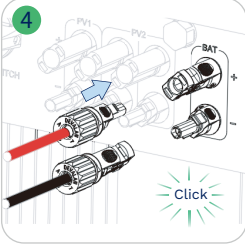
Procedure		
Step 1	<ul style="list-style-type: none"> • Unscrew the battery connector counterclockwise. • Remove the insulator. • Remove the inner cable gland. 	
Step 2	<ul style="list-style-type: none"> • Strip the insulation from each DC cable by 7-8mm. • The conduct core-section: 2.5-4 mm². • Assemble cable ends with crimp contacts by crimping pliers. 	
Step 3	<ul style="list-style-type: none"> • Check the cable connection of the battery for polarity correctness and ensure that the open-circuit voltage in any case does not exceed the input limit of 600V. • Connect the battery connectors to the inverter. There should be a "click" if it is plugged in correctly. 	 

3.3.4 AC Wiring Connection

3.3.4.1 Grid Connection

 WARNING	<p>Before connecting, please make sure all requirements listed below are followed.</p> <ul style="list-style-type: none"> • Use the Grid Connector from the accessory box. Damage to the device due to the use of incompatible connector shall not be covered by the warranty. • An independent three or four-pole circuit breaker must be installed on the output side of the inverter to ensure safe disconnection from the grid. • Multiple inverters cannot share one circuit breaker. • Never connect a load between the inverter and the circuit breaker. • Do not connect the AC circuit breaker until all inverter electrical connections are completed.
---	---

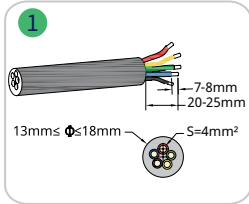
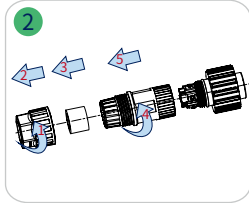
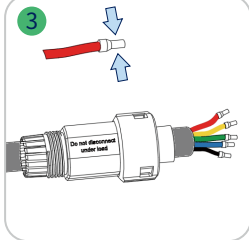
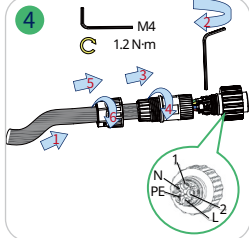
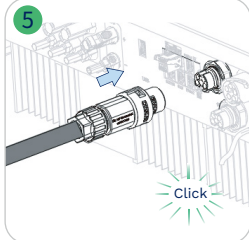
Procedure		
Step 1	<ul style="list-style-type: none"> • Thread the AC cable of appropriate length through the waterproof terminal. • Remove the cable jacket by 20-25 mm, and strip the wire insulation by 7-8 mm. • The conduct core-section: 4mm². 	
Step 2	<ul style="list-style-type: none"> • Unscrew the Grid connector counterclockwise. • Disassemble the parts in sequence. 	
Step 3	<ul style="list-style-type: none"> • Press the connectors tightly on the cable conductor core. Make sure the cable jacket is not locked within the connector. 	
Step 4	<ul style="list-style-type: none"> • Fix all cables to the corresponding terminals with a torque of 1.2 N•m, according to markings on the connector with a screwdriver. Make sure the L/N/PE are correctly assembled. • Assemble the parts in sequence. 	
Step 5	<ul style="list-style-type: none"> • Tighten the waterproof terminal clockwise • Connect the grid connector to the inverter. There should be a "click" sound, if it is plugged in correctly. 	

 <p>NOTICE</p>	<ul style="list-style-type: none"> If you need to connect Diesel Generator (GEN) Connector, please contact Hoymiles for more information.
--	--

3.3.4.2 EPS Connection

HYT-HV series has On-grid and Off-grid function, the inverter will deliver output power through the GRID port when the grid is on, and it will deliver output power through the EPS port when the grid is off. A standard PV installation typically consists of connecting the inverter to both panels and batteries. When the system is not connected to the batteries, the manufacturer strongly advises that the backup function not be used. The manufacturer will not honor the standard warranty and will not be liable for any consequences arising from users not following this instruction.

 <p>WARNING</p>	<p>Before connecting, please make sure all requirements listed below are followed.</p> <ul style="list-style-type: none"> Use the Grid Connector from the accessory box. Damage to the device due to the use of an incompatible connector shall not be covered by the warranty. An independent three or four-pole circuit breaker must be installed on the output side of the inverter to ensure safe disconnection from the grid. Multiple inverters cannot share one circuit breaker. Never connect a load between the inverter and the circuit breaker Make sure the EPS load power rating is within the EPS output rating, otherwise the inverter will shut down with an “overload” warning.
---	---

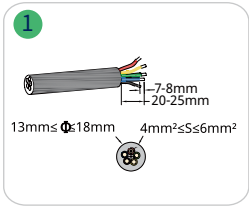
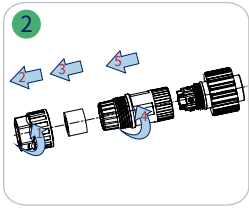
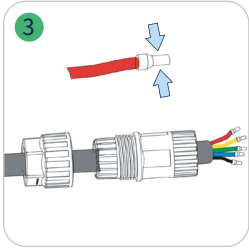
Procedure		
Step 1	<ul style="list-style-type: none"> Thread the AC cable of appropriate length through the waterproof terminal. Remove the cable jacket by 20-25 mm, and strip the wire insulation by 7-8 mm. The conduct core-section: 4-6 mm². 	
Step 2	<ul style="list-style-type: none"> Unscrew the GEN connector counterclockwise. Disassemble the parts in sequence. 	
Step 3	<ul style="list-style-type: none"> Press the connectors tightly on the cable conductor core. Make sure the cable jacket is not locked within the connector. 	

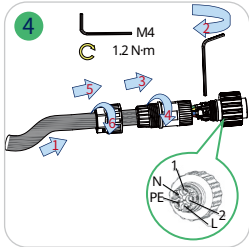
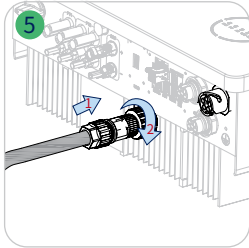
<p>Step 4</p>	<ul style="list-style-type: none"> Fix all cables to the corresponding terminals with a torque of 1.2 N•m, according to markings on the connector with a screwdriver. Make sure the L/N/PE are correctly assembled. Assemble the parts in sequence. 	
<p>Step 5</p>	<ul style="list-style-type: none"> Tighten the waterproof terminal clockwise. Connect the EPS connectors to the inverter, and tighten it firmly. 	

3.3.5 Communication Wiring Connection

Detailed pin functions of each port on the communication interfaces are as follows.

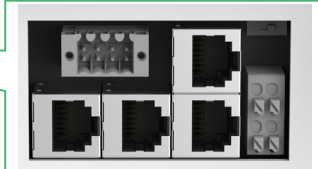
<table border="1"> <tr> <th>DI</th> <th colspan="3">DRM</th> </tr> <tr> <td>2</td> <td>4</td> <td>6</td> <td>8</td> </tr> <tr> <td>IN-</td> <td>D2/6</td> <td>D4/8</td> <td>REF</td> </tr> <tr> <td>1</td> <td>3</td> <td>5</td> <td>7</td> </tr> <tr> <td>IN+</td> <td>D1/5</td> <td>D3/7</td> <td>COM</td> </tr> </table>	DI	DRM			2	4	6	8	IN-	D2/6	D4/8	REF	1	3	5	7	IN+	D1/5	D3/7	COM	<table border="1"> <tr> <td>8-485A_2</td> <td>7-485B_2</td> </tr> <tr> <td>6-485A_1</td> <td>5-485B_1</td> </tr> <tr> <td>4-CANL</td> <td>3-CANH</td> </tr> <tr> <td>2-DI IN-</td> <td>1-DI IN+</td> </tr> </table> <p>Para1</p>	8-485A_2	7-485B_2	6-485A_1	5-485B_1	4-CANL	3-CANH	2-DI IN-	1-DI IN+	<table border="1"> <tr> <td colspan="2">120 Ohm</td> </tr> <tr> <td>ON</td> <td>OFF</td> </tr> </table>	120 Ohm		ON	OFF
DI	DRM																																	
2	4	6	8																															
IN-	D2/6	D4/8	REF																															
1	3	5	7																															
IN+	D1/5	D3/7	COM																															
8-485A_2	7-485B_2																																	
6-485A_1	5-485B_1																																	
4-CANL	3-CANH																																	
2-DI IN-	1-DI IN+																																	
120 Ohm																																		
ON	OFF																																	
<table border="1"> <tr> <td>8-NC</td> <td>7-NC</td> <td>6-NC</td> <td>5-485B</td> <td>4-485A</td> <td>3-NC</td> <td>2-NC</td> <td>1-NC</td> </tr> </table> <p>Meter</p>	8-NC	7-NC	6-NC	5-485B	4-485A	3-NC	2-NC	1-NC	<table border="1"> <tr> <td>8-485B</td> <td>7-485A</td> <td>6-NC</td> <td>5-CANL</td> <td>4-CANH</td> <td>3-NTC-</td> <td>2-NC</td> <td>1-NTC+</td> </tr> </table> <p>BMS</p>	8-485B	7-485A	6-NC	5-CANL	4-CANH	3-NTC-	2-NC	1-NTC+	<table border="1"> <tr> <td>8-485A_2</td> <td>7-485B_2</td> <td>6-485A_1</td> <td>5-485B_1</td> <td>4-CANL</td> <td>3-CANH</td> <td>2-DI IN-</td> <td>1-DI IN+</td> </tr> </table> <p>Para2</p>	8-485A_2	7-485B_2	6-485A_1	5-485B_1	4-CANL	3-CANH	2-DI IN-	1-DI IN+	<table border="1"> <tr> <td colspan="2">DO1</td> </tr> <tr> <td>1</td> <td>2</td> </tr> <tr> <td>NO1</td> <td>COM1</td> </tr> </table>	DO1		1	2	NO1	COM1	
8-NC	7-NC	6-NC	5-485B	4-485A	3-NC	2-NC	1-NC																											
8-485B	7-485A	6-NC	5-CANL	4-CANH	3-NTC-	2-NC	1-NTC+																											
8-485A_2	7-485B_2	6-485A_1	5-485B_1	4-CANL	3-CANH	2-DI IN-	1-DI IN+																											
DO1																																		
1	2																																	
NO1	COM1																																	
			<table border="1"> <tr> <td colspan="2">DO2</td> </tr> <tr> <td>1</td> <td>2</td> </tr> <tr> <td>NO2</td> <td>COM2</td> </tr> </table>	DO2		1	2	NO2	COM2																									
DO2																																		
1	2																																	
NO2	COM2																																	

Label	Description
Meter (485A, 485B)	For the Smart Meter.
BMS (CANH, CANL, 485A, 485B)	For Li-ion battery communication via CAN or RS485.
DRM (D1/5, D2/6, D3/7, D4/8, REF, COM)	For external Demand Response Enabling Device.
DI (IN-, IN+)	Dry-contact input of external bypass contactor.
Parallel (DI IN+, DI IN-, CANH, CANL, 485A_1, 485B_1, 485A_2, 485B_2)	For parallel operation.
120 Ohm (ON, OFF)	120 Ohm termination resistor for parallel operation.
DO1 (NO1, COM1)	Dry-contact output. The DO1 will control the bypass contactor under certain logic.
DO2 (NO2, COM2)	Dry-contact output. The DO2 can be set to one of the functions as follows: Earth Fault Alarm, Load Control, Backup Load Smart Control and Generator Control.

3.3.5.1 BMS Connection

BMS is used to communicate with the compatible Li-ion battery. If lead-acid battery is selected to work with this inverter, battery sensor in packing list shall be used to monitor the battery temperature.

 <p>NOTICE</p>	<ul style="list-style-type: none"> • Connection of communication box is mandatory, no matter wirings or not.
--	---

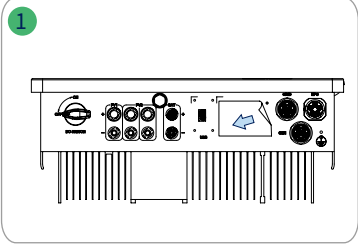
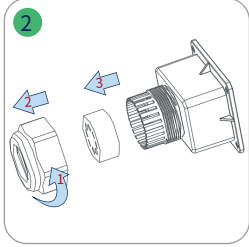
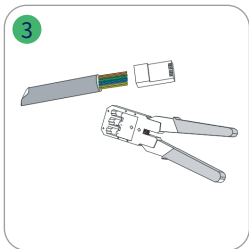
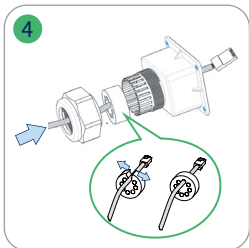
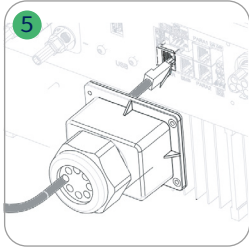
Procedure		
<p>Step 1</p> <ul style="list-style-type: none"> • Peel the stickers off from the communication port. 		
<p>Step 2</p> <ul style="list-style-type: none"> • Unscrew the communication box counterclockwise. • Disassemble the parts in sequence. 		
<p>Step 3</p> <ul style="list-style-type: none"> • Strip the insulation layer of the communication cable with an ethernet wire stripper, and lead the corresponding signal cables out. Insert the stripped communication cable into the RJ45 plug in the correct order, and crimp it with a crimper. • The BMS or battery sensor pin definition is shown in chapter 3.3.5. 		
<p>Step 4</p> <ul style="list-style-type: none"> • Thread the cable of an appropriate length through the communication box. • Clip the ethernet cable into the rubber ring. 		
<p>Step 5</p> <ul style="list-style-type: none"> • Insert the RJ45 plug into the front plug connector until it clicks. • Tighten the cable gland. 		

<p>Step 6</p>	<ul style="list-style-type: none"> • Install communication box with screws. • Connect the other end of the BMS cable to the battery, following the battery’s manual instructions. 	
---------------	---	--

3.3.5.2 Smart Meter and CT Connection

A Smart Meter with the CT in the accessory box is necessary for system installation, and is used to provide the operating condition of the inverter via RS485 communications.

<p>WARNING</p>	<p>Before connecting the Smart Meter and CT, ensure that the AC cable is totally isolated from the AC power source.</p>
<p>NOTICE</p>	<ul style="list-style-type: none"> • One smart meter can be used with only one HYT-HV inverter. • Three CTs must be used for one smart meter and must be connected on the same phase with the smart meter power cable. • There is a symbol (arrow) or label on the cell of CTs that indicates the correct mechanical orientation of the CT on the conductor under measurement. Please identify the arrow or label before installing the CT.

Procedure

<p>Step 1</p>	<ul style="list-style-type: none"> • Place the smart meter in or near the grid distribution box right after the utility meter. • Connect grid L1/L2/L3/N to meter’s terminals 3/6/9/10. • Clamp three CTs to L1/L2/L3/N and connect wirings to 13/14, 16/17, and 19/21 Respectively.
---------------	---

<p>Step 2</p>	<ul style="list-style-type: none"> • Connect the communication cable between the inverter and smart meter.
---------------	---

3.3.5.3 DRM Connection

DRM is designed to support several demand response modes by certain control signals, which are used for Australia and New Zealand. Detailed connection of DRM is shown as below.

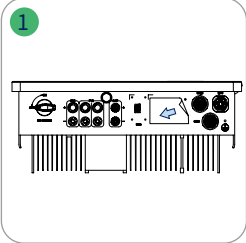
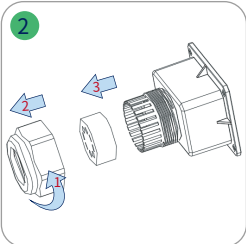
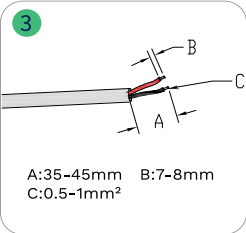
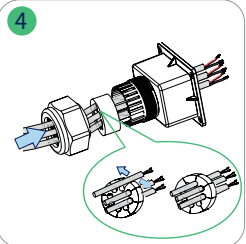
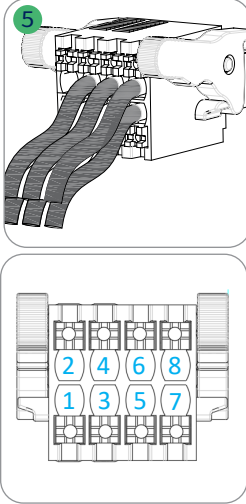
Procedure		
Step 1	<ul style="list-style-type: none"> Peel the stickers off from the communication port. 	
Step 2	<ul style="list-style-type: none"> Unscrew the communication box counterclockwise. Disassemble the parts in sequence. 	
Step 3	<ul style="list-style-type: none"> Strip the insulation layer of the communication cable, and lead the corresponding signal cables out. Press the terminal. 	 <p>A:35-45mm B:7-8mm C:0.5-1mm²</p>
Step 4	<ul style="list-style-type: none"> Thread the cable of appropriate length through the communication box. Clip the cable into the Rubber ring. 	
Step 5	<ul style="list-style-type: none"> Plug the wires into the terminal block firmly according following tables. 	

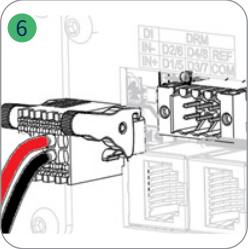
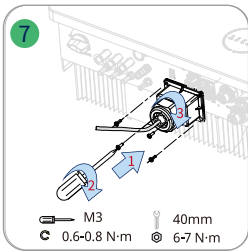
<p>Step 5</p>	<ul style="list-style-type: none"> For DRED, wiring from the No.3 to No.8 holes. The function of each connection position is shown below. <table border="1" data-bbox="391 327 879 443"> <tr> <td>NO.</td> <td>4</td> <td>6</td> <td>8</td> </tr> <tr> <td>Function</td> <td>DRM2/6</td> <td>DRM4/8</td> <td>REFGEN</td> </tr> <tr> <td>NO.</td> <td>3</td> <td>5</td> <td>7</td> </tr> <tr> <td>Function</td> <td>DRM1/5</td> <td>DRM3/7</td> <td>COM/DRM0</td> </tr> </table>	NO.	4	6	8	Function	DRM2/6	DRM4/8	REFGEN	NO.	3	5	7	Function	DRM1/5	DRM3/7	COM/DRM0	<ul style="list-style-type: none"> For Remote Shutdown, wiring the No.7 and No.8 holes. The function of each connection position is shown below. <table border="1" data-bbox="1050 311 1348 450"> <tr> <td>NO.</td> <td>8</td> </tr> <tr> <td>Function</td> <td>REFGEN</td> </tr> <tr> <td>NO.</td> <td>7</td> </tr> <tr> <td>Function</td> <td>COM/DRM0</td> </tr> </table>	NO.	8	Function	REFGEN	NO.	7	Function	COM/DRM0
NO.	4	6	8																							
Function	DRM2/6	DRM4/8	REFGEN																							
NO.	3	5	7																							
Function	DRM1/5	DRM3/7	COM/DRM0																							
NO.	8																									
Function	REFGEN																									
NO.	7																									
Function	COM/DRM0																									
<p>Step 6</p>	<ul style="list-style-type: none"> Pull the wires outward to check whether they are fully inserted and cannot be pulled out easily. Insert the terminal block into the connector until the terminal block clicks into place. 																									
<p>Step 7</p>	<ul style="list-style-type: none"> Tighten the cable gland. 																									

3.3.5.4 DI Connection

There is an integrated DI (IN+, IN-) as the dry-contact input to the bypass contactor of the inverter. The connection method is the same as that described in Chapter 3.3.5.3. Wiring the No.1 and No.2 holes if used, and the function of each connection position is shown below.

NO.	2
Function	IN-
NO.	1
Function	IN+

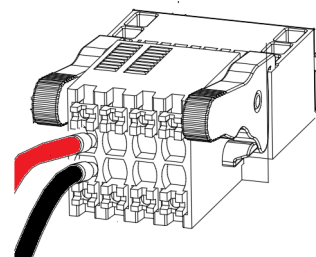
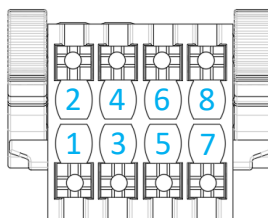

3.3.5.5 DO Connection

The inverter has integrated a multiple-function dry-contact (DO1 and DO2). The DO1 can control the external bypass contactor if used, for more information please contact Hoymiles technical support team. The DO2 can be set to one of the functions as follows, Earth Fault Alarm, Load Control, and Generator Control. The connection method is the same as that described in Chapter 3.3.5.3. The connection position is shown below.

NO.	DO1 - 1	DO1 - 2
Function	NO1	COM1
NO.	DO2 - 1	DO2 - 2
Function	NO2	COM2

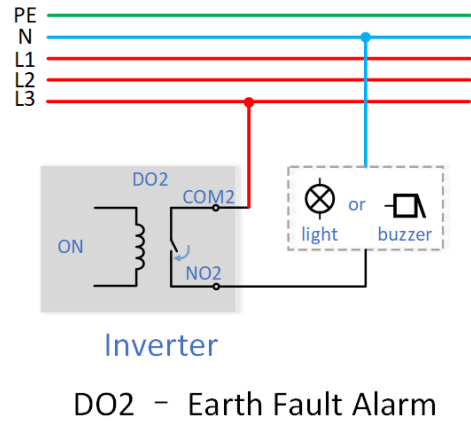
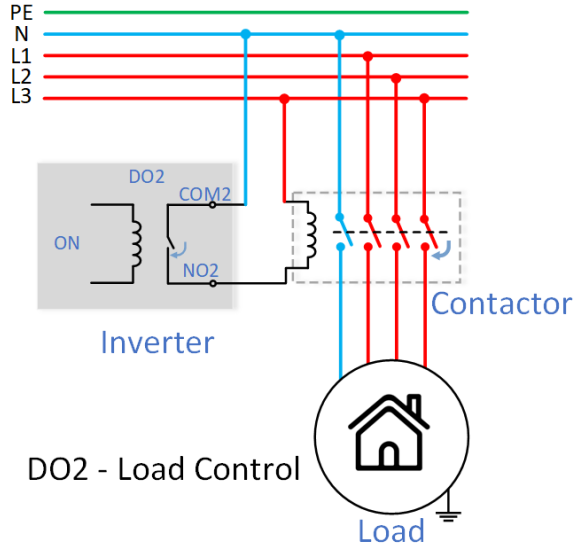
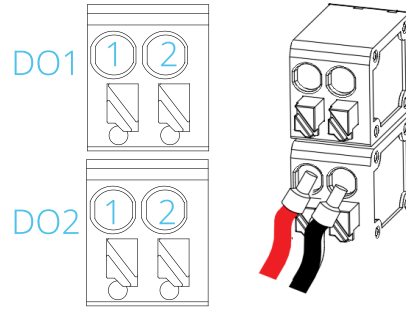

3.3.5.6 Parallel Connection

The parallel function is in developing and could be realized through OTA. For more information, please contact Hoymiles technical support team.

3.3.6 DTS Connection

DTS-WIFI-G1 and DTS-4G-G1 Procedure				
Steps	<ul style="list-style-type: none"> Remove the DTS port cover plate. Insert the DTS into the USB port. Fasten the screws tightly. 			
		<p>M3</p> <p>0.6-0.8 N·m</p>		

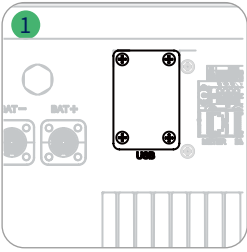
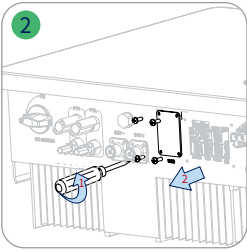
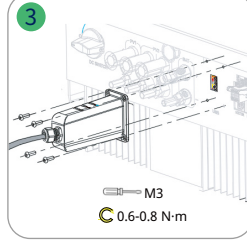
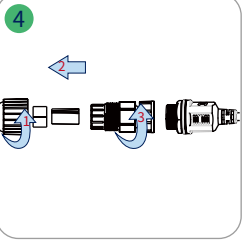
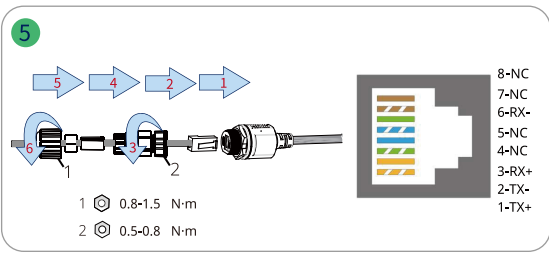
DTS-Ethernet-G1 Procedure		
Step 1&2	<ul style="list-style-type: none"> Remove the DTS port cover plate. 	 
Step 3&4	<ul style="list-style-type: none"> Insert the DTS-Ethernet to the USB port, and fasten the screws tightly. Unscrew the swivel nut from the connector. 	 
Step 5	<ul style="list-style-type: none"> Insert the RJ45 (pin definition is shown in the right figure) plug into the connector until there is an audible click sound. Thread the cable of an appropriate length through the connector. Tighten the cable gland. 	 <p> 8-NC 7-NC 6-RX- 5-NC 4-NC 3-RX+ 2-TX- 1-TX+ </p>

Indicator	Status	Description
RUN	ON	DTS is powered on.
	OFF	DTS is not powered on.
COM	ON	Proper communication with the inverter.
	OFF	Improper communication with the inverter.
NET	ON	Proper communication with Cloud.
	OFF	Improper communication with Cloud.
	BLINK	Improper communication with Cloud, but the network is connected.

3.4 Operation

3.4.1 S-Miles Cloud Application

The S-Miles Cloud application has been developed for Hoymiles' hybrid inverter and offers the following features,

- a. Network configuration;
- b. Local installation assistant;
- c. System monitoring;

Please download the S-Miles Cloud App from the Google Play Store or the Apple App Store. A QR code can also be scanned on the back of this User Manual to download the App. Please refer to the DTS user manual from www.hoymiles.com/resources/download/ for details.

3.4.2 Commissioning

 WARNING	<p>Before commissioning the inverter, make sure:</p> <ul style="list-style-type: none"> • The inverter is correctly and firmly mounted; • The inverter DC switch and external circuit breaker are disconnected; • Check wiring according to “3.3 Electrical Wiring Connection”; • Unused terminals must be sealed using the corresponding sealing plugs; • Nothing is left on the top of the inverter and battery; • Cables are routed in a safe place or protected against mechanical damage; • Warning signs and labels are intact.
---	--

Procedure	
Step 1	Wire the inverter to the AC circuit breakers.
Step 2	Rotate the DC switch to “ON”.
Step 3	Connect the DC circuit breaker between the battery and the inverter, and power on the battery pack if it’s required.
Step 4	Establish a communication connection between the mobile phone and DTS. Configure the parameters in Storage Toolkit and Network Config referring to “3.4.2 S-Miles Cloud APP”. Then use the System Self-test function to detect if there is a problem with the system.
Step 5	Operate the inverter and the system will work properly.

3.4.3 Decommissioning

 NOTICE	<ul style="list-style-type: none"> • Please strictly proceed as described in this section. Otherwise, it will be a danger to life due to lethal voltages or result in irreversible damage to the inverter.
--	---

Procedure	
Step 1	Stop the inverter from working via Hoymiles APP.
Step 2	Rotate the DC switch to the “OFF” position.
Step 3	Turn off the DC circuit breaker between the inverter and the battery.
Step 4	Turn off the AC circuit breakers of GRID, EPS and GEN.
Step 5	Wait at least 10 minutes after the LED indicators turn off to release the internal energy.
Step 6	Disconnect all the power cables. Disconnect all the communication cables. Remove DTS and power meter.
Step 7	Remove the inverter from the wall, and remove the bracket if necessary. Pack the inverter and accessories.

4. Troubleshooting

When the system is in alarm, please log into the S-Miles Cloud APP to review. The possible causes and their troubleshooting are detailed in the following table:

Display	Possible Cause	Handling Suggestions
Grid Overvoltage	The grid voltage is higher than the permissible range.	Generally, the inverter will reconnect to the grid after the grid recovers. If the alarm occurs frequently: 1. Make sure the safety country of the inverter is set correctly. 2. Make sure that the grid voltage in your area is stable and within the normal range. 3. Check whether the cross-sectional area of the AC cable meets the requirement. 4. If the alarm persists, contact Hoymiles technical support team.
Grid Undervoltage Undervoltage	grid voltage is lower than the permissible range.	Generally, the inverter will reconnect to the grid after the grid recovers. If the alarm occurs frequently: 1. Make sure the safety country of the inverter is set correctly. 2. Make sure that the grid voltage in your area is stable and within the normal range. 3. Check whether the AC cable is firmly in place. 4. If the alarm persists, please contact Hoymiles technical support team.
Grid Overfrequency	The grid frequency is higher than the permissible range.	Generally, the inverter will reconnect to the grid after the grid recovers. If the alarm occurs frequently: 1. Make sure the safety country of the inverter is set correctly. 2. Make sure that the grid frequency in your area is stable and within the normal range. 3. If the alarm persists, please contact Hoymiles technical support team.
Grid Underfrequency	The grid frequency is lower than the permissible range.	
No Grid	The inverter detects that there is no grid connected.	Generally, the inverter will reconnect to the grid after the grid recovers. If the alarm occurs frequently: 1. Check whether the grid supply is reliably. 2. Check whether the AC cable is firmly in place. 3. Check whether the AC cable is correctly connected. 4. Check whether the AC circuit breaker is disconnected. 5. If the alarm persists, contact Hoymiles technical support team.
Residual Current Fault	The residual leakage current is too high.	1. The alarm can be caused by high ambient humidity, and the inverter will reconnect to the grid after the environment is improved. 2. If the environment is normal, check whether the AC and DC cables are well insulated. 3. If the alarm persists, contact Hoymiles technical support team.
PV Reverse Connection	The inverter detects that the PV strings are reversely connected.	1. Check whether the corresponding string is of reverse polarity. If so, disconnect the DC switch and adjust the polarity when the string current drops below 0.5A. 2. If the alarm persists, contact Hoymiles technical support team.
PV Undervoltage	The PV voltage is lower than the permissible range.	1. Check whether the DC cable is firmly in place. 2. Check whether there is a PV module shaded. If so, remove the shade and ensure the PV module is clean. 3. Check whether the PV module is in abnormal aging. 4. If the alarm persists, contact Hoymiles technical.
PV Overvoltage	The PV voltage is higher than the permissible range.	1. Check the specification and numbers of corresponding string PV modules. 2. If the alarm persists, contact Hoymiles technical support team.

Display	Possible Cause	Handling Suggestions
Over Temperature	The temperature inside the inverter is higher than the permissible range.	<ol style="list-style-type: none"> 1. Make sure that the installation complies with the instructions from User Manual. 2. Check whether the alarm "Fan Fault" occurs. If so, replace the faulty fan. 3. If the alarm persists, contact Hoymiles technical support team.
Isolation Fault	The ground insulation impedance of the PV string is too low.	<ol style="list-style-type: none"> 1. Use a multimeter to determine if the resistance between the earth and the inverter frame is close to zero. If not, please ensure that the connection is good. 2. If the humidity is too high, an isolation fault may occur. Attempt to restart the inverter. If the fault persists, check it again when the weather turns fine. 3. Check the resistance to ground from the PV module/ cable. Take corrective measures in case leading to a short circuit or damaged insulation layer. 4. If the alarm persists, contact Hoymiles technical support team.
Arc Fault	The inverter detects that there is an arc fault.	<ol style="list-style-type: none"> 1. Disconnect the DC switch and check whether DC cables are damaged and whether the wiring terminals are loose or in poor contact. If so, take corresponding corrective measures. 2. After taking corresponding measures, reconnect the DC switch. 3. If the alarm persists, contact Hoymiles technical support team.
EPS Load Overpower	The EPS load power is higher than the permissible range.	<ol style="list-style-type: none"> 1. Reduce the power of EPS loads, or remove some EPS loads. The inverter will restart automatically. 2. If the alarm persists, contact Hoymiles technical support team.
Meter Reverse Connection	The inverter detects that the Meter or CT is reverse connected.	<ol style="list-style-type: none"> 1. Make sure that the installation complies with the instructions from User Manual. 2. If the alarm persists, please contact Hoymiles technical support team.
Meter Communication Fault	The inverter detects that there is a meter communication fault.	<ol style="list-style-type: none"> 1. Check whether the Meter communication cable and terminal are abnormal. 2. Reconnect the Meter communication cable. 3. If the alarm persists, please contact Hoymiles technical support team.
Battery Reverse Connection	The inverter detects that the battery wirings are reversely connected.	<ol style="list-style-type: none"> 1. Check the battery for polarity correctness, and correct it if necessary. 2. If the alarm persists, please contact Hoymiles technical support team.
Battery Voltage Fault	The battery voltage is higher than the permissible range.	<ol style="list-style-type: none"> 1. Check if the battery input voltage is within the normal range. 2. If the alarm persists, please contact Hoymiles technical support team.
BMS Communication Fault	The inverter detects that there is a BMS communication fault.	<ol style="list-style-type: none"> 1. Check whether the BMS communication cable and terminal are abnormal. 2. Reconnect the BMS communication cable. 3. If the alarm persists, please contact Hoymiles technical support team.

Display	Possible Cause	Handling Suggestions
BMS Battery Alarm	The inverter detects that there is a battery fault from BMS.	Try to restart the battery. If the fault persists, contact the battery manufacturer.
BMS Battery Fault	The inverter detects that there is a battery fault from BMS.	Try to restart the battery. If the fault persists, contact the battery manufacturer.
Relay Fault	The inverter detects that there is a relay self-check fault.	Try to restart the inverter. If the fault persists, contact Hoymiles technical support team.

5. Technical Datasheet

Model	HYT-5.0HV-EUG1	HYT-6.0HV-EUG1	HYT-8.0HV-EUG1	HYT-10.0HV-EUG1	HYT-12.0HV-EUG1
Battery					
Battery Type	Li-ion				
Nominal Battery Voltage (V)	500				
Voltage Range (V)	170-600				
Max. Charge Current (A)	20	20	30	30	30
Max. Discharge Current (A)	20	20	30	30	30
Rated Power (W)	5000	6000	8000	10000	10000
Charging Strategy	Self-adaption to BMS				
PV Input					
Max. PV Input Power (W)	7500	9000	12000	15000	15000
Max. PV Input Voltage (V)	1000				
Nominal Input Voltage (V)	720				
MPPT Voltage Range (V)	200-950				
Start-up Voltage (V)	250				
Number of MPPTs	2	2	2	2	2
Max. Number of PV String per MPPT	1/1	1/1	1/1	1/2	1/2
Max. PV Input Current (A)	14/14	14/14	14/14	14/28	14/28
Short-circuit Current of PV Input (A)	17/17	17/17	17/17	17/34	17/34
AC Input and Output (On-grid)					
Nominal Output Apparent Power (VA)	5000	6000	8000	10000	12000
Max. Output Apparent Power (VA)	5500	6600	8800	11000	12000
Max. Input Apparent Power (VA)	10000	12000	16000	16000	16000
Nominal AC Voltage (V)	400/380, 3L/N/PE				
Nominal Grid Frequency (Hz)	50/60				
Max. Output Current (A)	8.3	10.0	13.3	16.7	17.4
Max. Input Current (A)	15.2	18.2	24.2	24.2	24.2
Power Factor	0.8 leading ... 0.8 lagging				
Total Harmonic Distortion (@nominal output)	<3%				
AC Output (Off-grid)					
Max. Output Apparent Power (VA)	5000	6000	8000	10000	12000
Peak Output Apparent Power (VA)	10000, 10s	12000, 10s	16000, 10s	16000, 10s	16000, 10s
Nominal AC Voltage (V)	400/380, 3L/N/PE				
Nominal AC Frequency (Hz)	50/60				
Max. Output Current (A)	8.3	10.0	13.3	16.7	17.4
Total Harmonic Distortion (@linear load)	<3%				

Model	HYT-5.0HV-EUG1	HYT-6.0HV-EUG1	HYT-8.0HV-EUG1	HYT-10.0HV-EUG1	HYT-12.0HV-EUG1
Efficiency					
Max. Efficiency	97.6%	97.6%	97.6%	97.6%	97.6%
Euro Efficiency	97.0%	97.0%	97.0%	97.0%	97.0%
Max. Battery to Load Efficiency	97.0%	97.0%	97.0%	97.0%	97.0%
MPPT Efficiency	99.9%	99.9%	99.9%	99.9%	99.9%
Protection					
Anti-islanding Protection	Integrated				
PV String Input Reverse Polarity Protection	Integrated				
Insulation Resistor Detection	Integrated				
Residual Current Monitoring Unit	Integrated				
AC Over Current Protection	Integrated				
AC Short Current Protection	Integrated				
AC Overvoltage and Undervoltage Protection	Integrated				
Surge Protection	DC Type II / AC Type III				
General					
Dimension (W × H × D) [mm]	502 × 486 × 202				
Weight (kg)	26				
Mounting	Wall Mounting				
Operation Temperature (°C)	-25 to + 65 (>45, derating)				
Relative Humidity	0-95%, no condensing				
Altitude (m)	≤2000				
Cooling	Natural convection				
Protection Degree	IP65				
Noise (dB [A])	<40				
User Interface	LED & App				
Communication with BMS	RS485, CAN				
Communication with Meter	RS485				
Communication Interface	RS485, Wi-Fi/Ethernet/4G (optional)				
Digital Input/output	DRM, 1 × DI, 2 × DO				
Isolation Method (Solar/Battery)	Transformerless / Transformerless				
Certifications and Standards					
Grid Regulation	EN 50549, VDE-AR-N 4105, AS/NZS 4777.2				
Safety Regulation	IEC 62109-1, IEC 62109-2				
EMC	EN 61000-6-1, EN 61000-6-3				

6. Contact Information



S-Miles Installer



S-Miles Enduser

China
No.18 Kangjing Road,
Hangzhou,
China
+86 571 2805 6101

General inquiry:
info@hoymiles.com
Technical support:
service@hoymiles.com

Visit <https://www.hoymiles.com/> for more informations.